

# PRODUCT SHEET

## Description:

Floor Hinge "Jump III", W/Soft Close & Hold,SS304, 100KG, Brushed, 10-15mm Glass, Anti-Wind Capability,, Door Width: Max. 1300mm, Door Height: Max. 2200mm,, Door Weight: Max. 100 KG, Opening Angle:., 140° Bi-Directional, WorkingTemperature:-40~60oC

## Item number:

15.24.265-0

Units	Box	Carton	HS Code	Barcode
Pcs.	1	6	8302100090	
				5704866485326

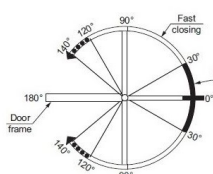
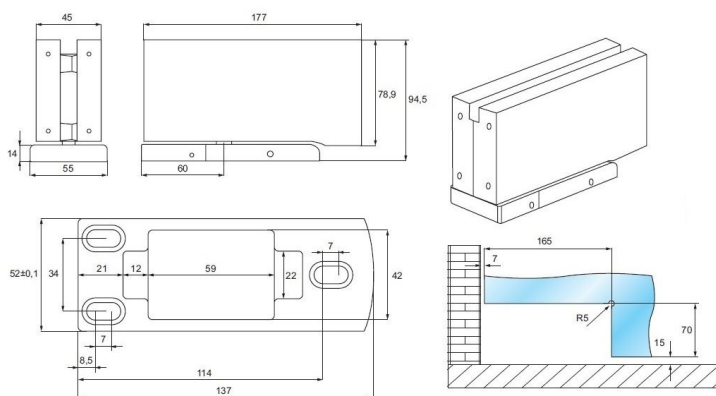
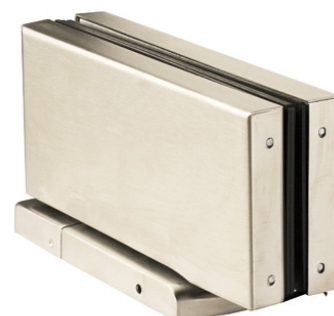

- Features:
1. Open angle: 140°
  2. Door hold open section: 90° and 140°-120° (Optional)
  3. Two speeds adjustable  
Valve 1: 90°-0°  
Valve 2: 30°-0°

Glass thickness	Application of rubber gasket Thickness (1.5 mm)
10 mm	4
12 mm	4
14 mm	2
16 mm	2

SISO A/S  
Mileparken 11  
DK-2740 Skovlunde  
Denmark  
VAT: DK 24786013

Phone +45 45 830 900  
www.siso.dk  
siso@siso.dk

Danske Bank  
Nytorv Branch  
Copenhagen  
SWIFT: DABADKKK

Account no.  
4180 3112 112936  
IBAN Account  
DK7230003112112936